

# Application Note 372-2

## Battery Testing

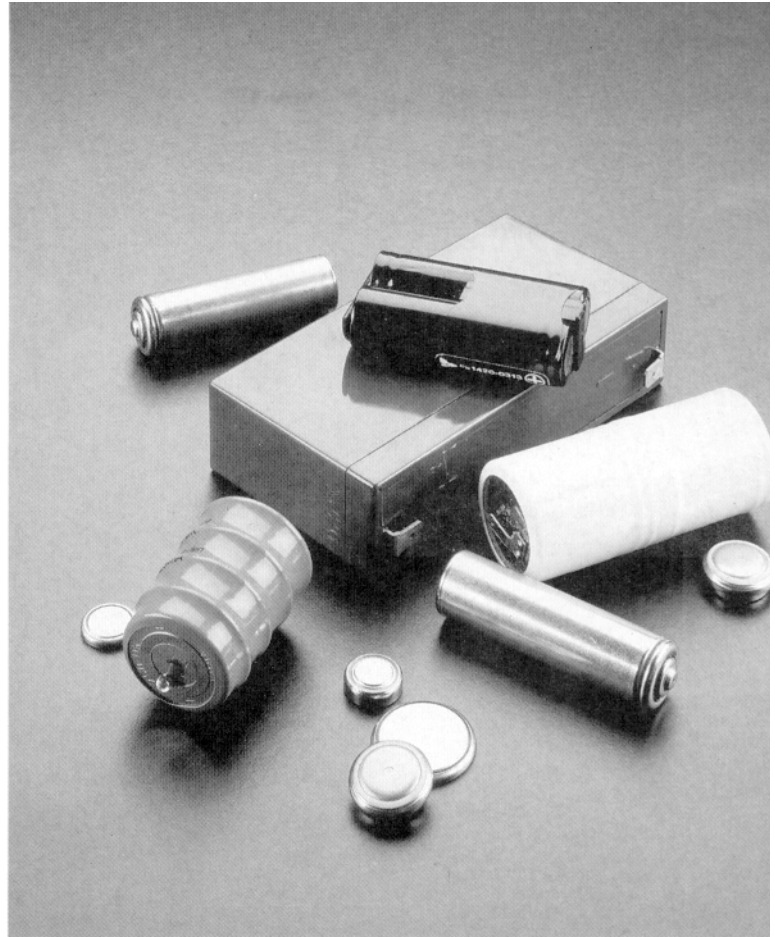
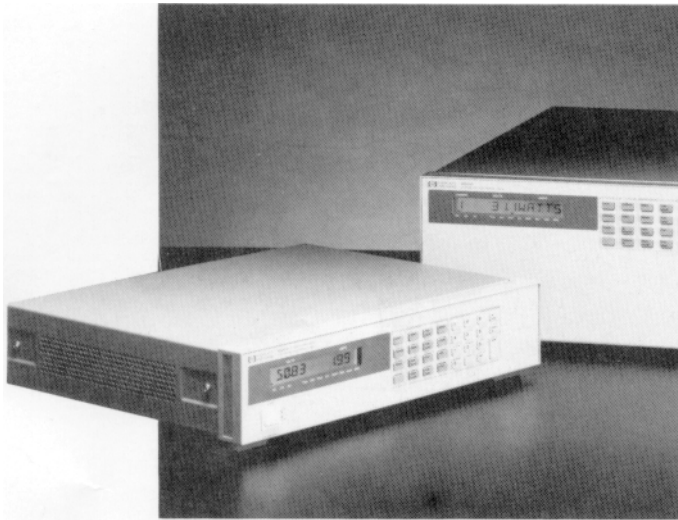
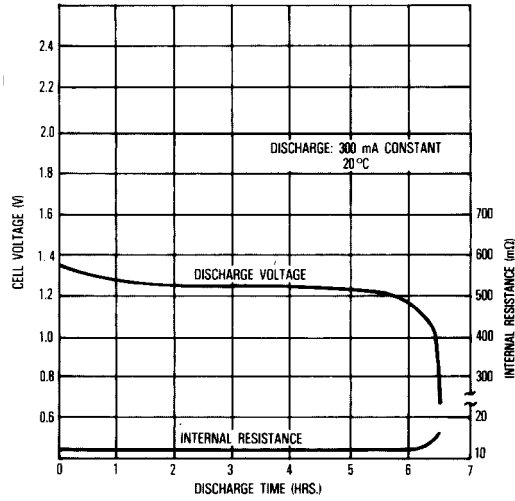

---

*An electronic load can be used to discharge batteries of various chemistries to determine actual capacity, capacity retention, and internal impedance.*

---



# Introduction

Increasing demand for portable DC power has risen from improvements in battery and motor design technology. More than ever before, portable DC powered products have become available in many diverse applications. Rechargeable batteries appear in all types of products from analytical electronic equipment to power tools and toys. In some instances, these diverse applications pose different requirements on the source of DC power. Fortunately, availability of many types of battery chemistries yield unique characteristics. Table 1 contains just some of the different battery types and their advantages.

Whether testing batteries in R&D or production environments, the test requirements for each of the different battery types are basically the same. Figure 1 shows a common test configuration. In general, the testing of a battery involves discharging it over a period of time to determine several specifications. This application note will concentrate on the test of secondary batteries because they require additional tests involving recharging. Nickel-cadmium batteries, in particular, are discussed because they are the most universally used type of secondary battery in today's demanding applications.

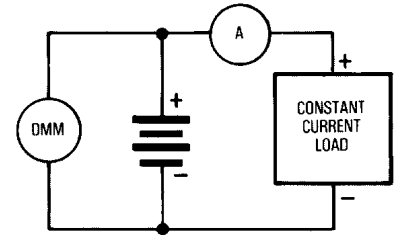

Figure 1. Common Test Configuration

Table 1. Characteristics and Applications of Different Battery Types.

	Nickel-Cadmium	Gelled Lead Acid	Lithium	Carbon Zinc	Alkaline	Silver Oxide	Mercuric Oxide
<b>Volts/Cell</b>	1.2	2.0	1.5 to 1	1.5	1.5	1.5	1.4
<b>Applications</b>	portable equipment, rechargeable	standby service, rechargeable	memory backup, pacemakers, electronic door locks, emergency locator transmitters	average use	good general purpose battery	button-sized cells for watches and hearing aids	button-sized cells for watches and hearing aids
<b>Charge Method</b>	CC	CV, float charge	N/A	N/A	N/A	N/A	N/A
<b>Cycle Life</b>	500+ cycles	200 cycles	N/A	N/A	N/A	N/A	N/A
<b>Life (Charged)</b>	3 mos. (-2%/day)	1 year	5-10+ years	1-5 years	5% loss/yr.	6% loss/yr.	4% loss/yr.
<b>Operating Temp.</b>	-20°C to 70°C	-20°C to 65°C	-55°C to 75°C	-5°C to 55°C	-30°C to 55°C	-20°C to 55°C	-10°C to 55°C
<b>Performance Comments</b>	high discharge rate, quick charge rate	high capacity	flat discharge, long life, wide temperature range, good energy density	low cost, sloping discharge, low energy density	good energy density, sloping discharge	flat discharge, more energy per unit volume than mercuric oxide	flat discharge

# Application Overview and Test Implementation

Seven standard test procedures <sup>1</sup> are used to verify certain electrical characteristics of secondary batteries:

1. **Rated capacity**
2. **Capacity retention**
3. **Effective internal resistance**
4. **Discharge rate effect on capacity at -20°C**
5. **Discharge rate effect on capacity at 23°C**
6. **Life cycle performance**
7. **Extended overcharge**

<sup>1</sup> as specified in ANSI® C18.2-1984, American National Standards

Other miscellaneous tests and procedures also involve discharging a battery such as: start-up voltage test, forced-discharge test, timed fast charge and dump-timed charge. Most battery tests typically require only about 1% accuracy unless otherwise specified. While battery tests do not require high accuracy, the tests must be very repeatable. Battery characteristics change with temperature so it is important to be able to control and monitor the temperature, usually to within  $\pm 2$  degrees C. Other equipment requirements to consider are: a current source for charging secondary batteries, a voltage monitor, a current monitor, a load for discharge current, and a time keeping device. More information about test equipment is given in the "Test Equipment Requirements" section later in this application note.

Note that a battery temperature rise of more than 5 degrees C above ambient may require supplemental cooling to prevent battery performance degradation due to elevated temperatures.

## Rated Capacity

The principal measurement of a battery's performance is its rated capacity. Capacity ratings are attained in an accelerated test approximating the battery's capacity in typical use. The capacity of a fully charged battery, at a fixed temperature, is defined as the product of the rated discharge current (in amperes) and the discharge time (in hours) to a specified minimum termination voltage (volts). See figure 2. A battery is considered completely discharged when it attains the specified minimum

voltage called the "end of discharge voltage"(EODV). The EODV for nickel-cadmium batteries is typically 1.1 to 0.9 Volts.

The term C or C-rate is used to define the discharge current rate (in amperes), and is numerically equal to rated capacity which is expressed in ampere-hours. The term 1C is defined as the rate of discharge that allows a battery to provide its rated current over a period of one hour.

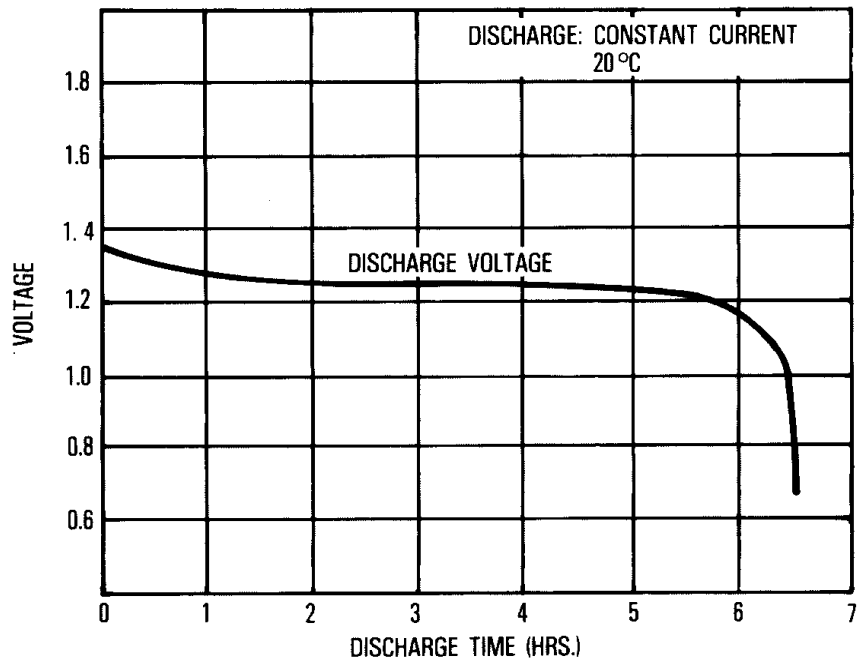

Figure 2. Typical Discharge Curve

Capacity varies with the rate of discharge as shown in figure 3. Testing for how discharge rate affects capacity is discussed later in more detail. Generally, lower discharge rates over longer periods of time yield higher values of total capacity. It is important to realize that since discharge rate affects how the value of C is determined, battery manufacturers must decide on a standard time of discharge. Since different values for capacity can be obtained for the same battery, capacity is generally determined over a "standard" period of time - from 5 to 20 hours at discharge rates from C/5 to C/20. A complete specification for capacity should therefore have a C rate and the period of time that was used to determine the capacity. For example, Capacity: 450 mAh @ 5 hour rate.

Average and maximum capacities are obtained by putting the battery through five successive charge/discharge stabilizing cycles. The batteries are given five stabilizing cycles where they are charged, discharged and rested at an ambient temperature of 23 degrees C. Batteries are charged at C/10 A for a period of from 20 to 24 hours and rested for a period of from 2 to 4 hours. The batteries are then discharged at a constant current of 1C amperes to an EODV of 0.9 volts.

The value of the capacity used in the following tests is the value obtained in the fifth stabilizing cycle. Also, the capacity obtained in the last three cycles must not be less than that stated by the manufacturer as rated capacity (1C).

## Capacity Retention

This test characterizes how much of a fully charged battery's capacity is retained over a long period of time under specific conditions. This time is sometimes referred to as the "shelf life" of the battery. This test is not to be confused with an attempt to characterize the self-discharge effect of the spontaneous internal chemical actions in batteries. Self-discharge occurs regardless of the battery's connection to an external circuit

The procedure to determine the effective capacity retention of a battery is relatively simple. Immediately following the 5 cycles of capacity measurement, the battery is fully recharged. It is then stored open circuit for a period of days at a specific temperature. Then it is discharged at a constant current rate to an EODV of 0.9 V as before. The capacity obtained should not be less than 37% of the rated capacity for the battery. The number of days of shelf life are typically provided for values of temperature from 23 degrees C to 50 degrees C.

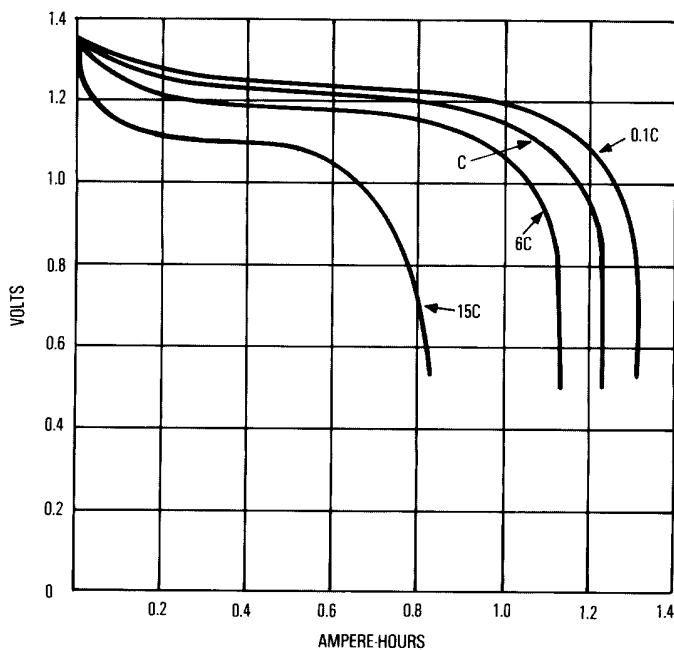

Figure 3. Effect of Discharge Rate on Capacity

---

## Effective Internal Impedance

Battery impedance is dependent on temperature, its state of charge, and the load frequency. The effective internal impedance is lower for a fully charged battery than it is for a discharged one. Having a low internal resistance is very important when the battery must support a high current for a short time. Low temperature, use, and long storage periods all increase a battery's internal resistance. Nickel-cadmium batteries also have a high effective capacitance. Their total effective impedance is so low that, in applications where they are continuously being "trickle-charged" at rates from 0.01C to 0.1C, they make excellent ripple filters. Resistance and impedance tests are explained in the following paragraphs.

### Resistance Test

The battery must be fully charged as outlined above. Batteries rated 5 Ah or less are discharged at 10C for 2 minutes and then switched to 1C. The battery voltage is recorded just prior to switching and again upon reaching its maximum value after switching. All voltage measurements are made at the terminals of the battery independently of the contacts used to carry current. The effective internal resistance ( $R_e$ ) is then calculated as follows:

$$R_e = \frac{\Delta V}{\Delta I} = \frac{V_L - V_H}{I_H - I_L}$$

$I_H, V_H$  = the current and voltage, recorded just prior to switching

$I_L, V_L$  = the current and maximum voltage, recorded after switching

### Impedance Test

The battery must be fully charged as outlined above. An AC current source ( $\sim 1$  kHz) is applied to the terminals of the battery. The AC current through the battery and the voltage across it are measured. The impedance is simply calculated as  $V/I$ . An interesting alternative testing method that yields the same result is to place a varying ( $\sim 1$  kHz) load across the fully charged battery instead of the AC power source.

### Discharge Rate Effect on Capacity

The rate of discharge has an effect on the total capacity of a battery. Heavy discharge rates decrease the total available capacity of a battery. The test is done at two temperatures: -20 degrees C and 23 degrees C. The battery is first fully charged at 23 degrees C and then immediately stored for 24 hours at an ambient temperature of -20 degrees C. It is then discharged at an ambient temperature of -20 degrees C at a constant current rate of 1C to an EODV of 0.8 volts. Then the procedure is repeated at discharge rates of 5C and C/5. The whole test is then repeated at a temperature of 23 degrees C to an EODV of 0.9 volts.

For each of the six discharge cycles, the manufacturer supplies the value of capacity to be expected as a percent of C1. Charging and discharging at temperatures below the specification sheet recommendation should be avoided.

### Life Cycle Performance

Life cycle testing is a measure of expected battery performance in actual service. Life cycle performance is characterized by dynamically

loading the battery in a simulated "real-life" situation for 50 or more charge and discharge cycles as follows:

The battery is given five stabilizing cycles in accordance with the previously outlined procedure.

#### Life Cycles 1 through 48

1. Charge 11 hours and 20 minutes at C/10
2. Discharge immediately at 1C for 40 minutes
3. No rest

#### Life cycles 49 and 50

1. Charge for 20 hours at C/10
2. Rest 2 to 4 hours
3. Discharge at 1C to 0.9 volts EODV

#### Repetition of Life Cycles

Repeat cycles 1 to 50 as desired.

The capacity at cycle 50, and multiples thereof, should be no lower than that stated for this procedure by the manufacturer.

### Extended Overcharge

The ability of a battery to withstand overcharge is determined by charging the battery at a constant current of C/10, or at the maximum overcharge rate recommended by the manufacturer, at an ambient temperature of 23 degrees C for 6 months. The battery should at no time show either electrolyte leakage or visual evidence of distortion beyond the standard maximum dimensions for that battery. When discharged at a constant current of 1C to an EODV of 0.9V, the battery should have a capacity equal to or greater than the extended overcharge capacity specification.

---

## Miscellaneous Tests

In addition to the tests already mentioned, there are also other miscellaneous tests performed on nickel-cadmium batteries. These tests usually involve high rate charge and/or discharge.

High rate discharge and charge of nickel-cadmium batteries is possible with today's new and better designed cells having advanced plate and cell construction. The low internal resistance of nickel-cadmium batteries yields high discharge currents. If they are discharged continuously under short circuit conditions, however self-heating may do irreparable damage. Continuous discharge at rates greater than IC should be prevented to avoid potentially hazardous conditions due to high internal gas pressure build-up.

Very high currents ( $>2C$ ) can be withdrawn in low duty cycle pulses providing that internal temperatures and pressures are maintained. Output capacity in any type of pulse discharge application is difficult to predict because of the infinite number of possible combinations of discharge time, rest time, and EODV. Simulation of actual events, as in the Life-Cycle test, is the best way to quantify a battery exposed to such conditions.

Many cells can be quick-charged at a rate up to  $C/3$  in as little as 3 to 5 hours instead of the standard 12 to 15 hours at the  $C/10$  rate. High rate charging should be done under controlled conditions where temperature, voltage, pressure, or some combination of these parameters can be monitored to assure they are within specifications.

One fast-charge method involves charging the battery at a rate exceeding the specified maximum charge rate for a finite period of time, after which the charge rate is reduced to currents below  $C/10$ . This method, called "timed fast charge", can indeed give a quick "boost" charge to a partially discharged battery, but unfortunately has the potential of permanently destroying the battery. The destruction occurs due to overcharging the battery because its unused capacity is unknown prior to charging.

A safer variation of the timed fast charge method is called "dump timed-charge" where the battery is first fully discharged ("dumped") to its EODV before recharging via the "timed fast charge" method. The "dump timed-charge" method has the advantage of knowing just how much energy must be pumped back into the battery to bring it to full capacity; the risk of overcharging is therefore eliminated.

One final test, called the "forced discharge test", determines the safety of a battery under certain abusive conditions. This test is very dangerous because, during the test, the battery is very likely to explode. The test must be done under extremely well controlled conditions in an explosion proof safety chamber to prevent personal injury. The test involves connecting a current source in series with the battery. The polarity is in the same direction as normal or short circuit current flow. See figure 4. The current source is set to a value such that the resultant current flow is greater than the short circuit current flow. This test simulates what may happen if a battery were improperly installed in a circuit where it may not be the only source in the application. Ideally the battery should withstand the stress, with some degree of margin, when the test currents are similar to actual conditions.

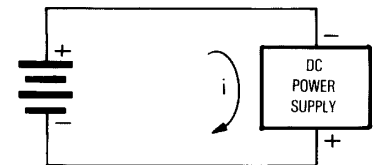

**Figure 4. Forced Discharge**

# Test Equipment Requirements

From the various tests described so far, we can see some common requirements for test equipment. All the tests require a discharge cycle using a constant current. A constant discharge current cannot be attained with a simple resistor because the battery voltage changes as current is drawn from it. An active device is required, such as an electronic load with a constant current mode of operation. Also note that, because many levels of constant current are used from test to test, you should be able to control the electronic load dynamically as the test demands.

The ability to control the load with a computer is important because discharge is typically over a long period of time and, if the test were not automated, constant attendance would be an unproductive use of an operator's time. Long term tests also bring about another requirement: reliability. The electronic load must be very reliable because, if it should fail, the test would take a long time to repeat.

In battery or single cell testing the electronic load only has to function down to the EODV, not zero volts. See figure 5. If the minimum load operating voltage is above the EODV for the battery being tested, two alternatives are available: stack more than one battery in series until the required voltage is reached (figure 6) or place a DC power supply (of sufficient voltage and current) in series with the battery (figure 7). A power supply applied in this way is sometimes called an "offset supply".

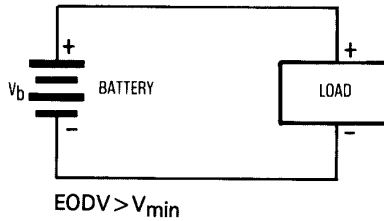

**Figure 5. Single Battery Test Configuration**

The first alternative (figure 6) requires a method of scanning the voltage of each battery in the stack so that when any one battery reaches its EODV, either the test can be halted or the battery switched out of the circuit and replaced by a short circuit. Even as each battery is switched out of the circuit, the discharge current will remain the same if the load has a constant current mode of operation.

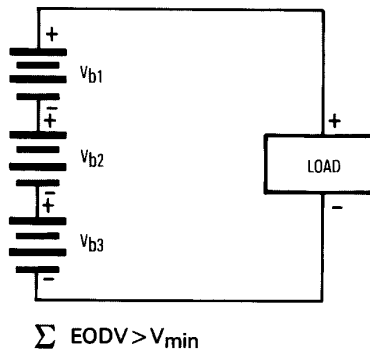

**Figure 6. Batteries in Series**

The second alternative (figure 7) shows that using a power supply may be more desirable because timed fast charge, dump-timed charge, and forced discharge tests all require a DC power source anyway. Additionally, a constant current power supply could then be used to test ampere-hour efficiency of secondary batteries. This rating is simply the ratio of the ampere-hours delivered during discharge to the ampere-hours required to restore the initial state of charge to the battery.

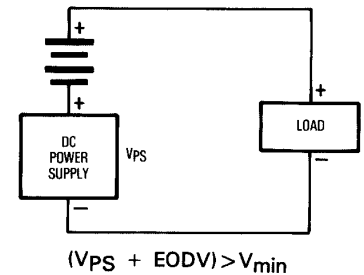

**Figure 7. Using an Offset DC Power Supply**

Voltage and current must be monitored throughout all the tests because actual battery voltage varies with the battery chemistry as well as the discharge rate involved. Therefore, a voltmeter and ammeter are required. They should be computer controlled so that the various tests can be halted when the EODV is reached. If an ammeter is unavailable, a current shunt can be used in conjunction with either a second voltmeter or a scanner.



# Battery Testing with HP Electronic Loads

Hewlett-Packard's Electronic Loads are ideally suited for battery test applications. Their many features make the test system easy to configure and provide safe, reliable, and repeatable operation.

The HP 6060A Electronic Load and the HP 6050A Electronic Load mainframe have the required constant-current modes as well as constant-resistance and constant-voltage modes. Built-in voltmeters and ammeters eliminate the need for external meters and provide measurement accuracy which, in most cases, greatly exceeds the 0.5 to 1% that is typically required.

These electronic loads can be controlled from their front panel, from a computer via HP-IB, or by a 0 to 10 volt analog signal. By varying the analog control input (up to 10 kHz), a

battery's effective internal impedance can be easily measured. The electronic load's built-in HP-IB interface makes it simple to connect any computer that supports HP-IB. HP's electronic loads are not limited to just being controlled over the bus. Measured current, voltage, power and complete status can also be read back over the bus so that time consuming discharge tests can be attended automatically. Hewlett-Packard's electronic loads truly provide a "One Box" solution.

Testing cells down to an EODV of 0.9 volts is easily done with the HP 6060A, HP 6063A, HP 60501A, HP 60502A, HP 60503A, or HP 60504A Electronic Loads. While the operating characteristics of these loads are guaranteed to meet all specifications above 3 volts, the DC operating characteristics extend below 3 volts

(see figure 8). This figure shows that at 0.9 volts the HP 6060A Electronic Load is capable of reliably drawing up to 27 amperes. That means an 80 Ah battery could be discharged to an EODV of 0.9 volts at a discharge rate of C/3. For applications requiring V/I characteristics below the operating curve of figure 8, Hewlett-Packard offers a full family of DC power supplies to be used as an offset supply.

Hewlett-Packard's full featured Electronic Load Family offers quality and reliability backed with a three year warranty. Refer to the 1990/91 DC Power Supply Catalog with Electronic Loads (HP Part Number 5952-4203) for more information about HP Electronic Loads.

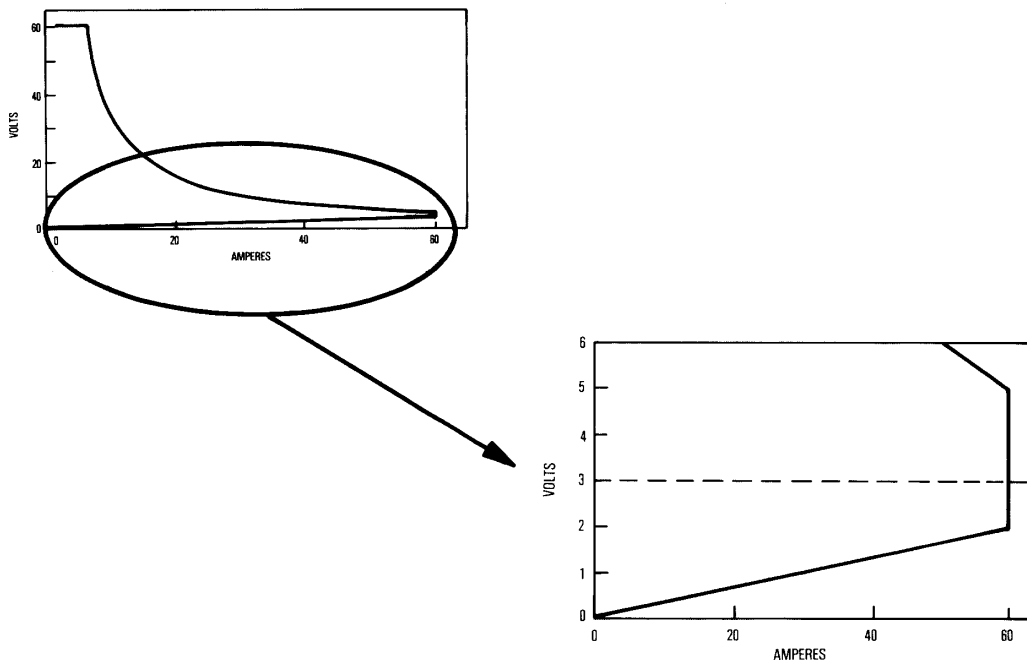

Figure 8. Operating Characteristics of an HP Electronic Load

## NOTES

---

## HP Sales and Support Office

For more information, call your local HP Sales Office listed in the telephone directory white pages. Ask for the Electronic Instruments Department.

### Or write to:

#### United States:

Hewlett-Packard Company  
4 Choke Cherry Road  
Rockville, MD 20850  
(301) 670-4300

Hewlett-Packard Company  
5201 Tollview Drive  
Rolling Meadows, IL 60008  
(312) 255-9800

Hewlett-Packard Company  
5161 Lankershim Blvd.  
No. Hollywood, CA 91601  
(818) 505-5600

Hewlett-Packard Company  
2015 South Park Place  
Atlanta, GA 30339  
(404) 955-1500

#### Canada:

Hewlett-Packard Ltd.  
6877 Goreway Drive  
Mississauga, Ontario L4V1M8  
(416) 678-9430

#### Australia/New Zealand:

Hewlett-Packard Australia Ltd  
31-41 Joseph Street  
Blackburn, Victoria 3130  
Melbourne, Australia  
(03) 895-2895

#### Europe/Africa/Middle East:

Hewlett-Packard S.A.  
Central Mailing Department  
P.O. Box 529  
1180 AM Amstelveen  
The Netherlands  
(31) 20/547 9999

#### Far East:

Hewlett-Packard Asia Ltd.  
22/F Bond Centre  
West Tower  
89 Queensway  
Central, Hong Kong  
(5) 8487777

#### Japan:

Yokogawa-Hewlett-Packard Ltd  
29-21, Takaido-Higashi 3-chome  
Suginami-ku, Tokyo 168  
(03) 331 6111

#### Latin America:

Latin American Region Headquarters  
Monte Pelvoux Nbr. 111  
Lomas De Chapultepec  
11000 Mexico, D.F. Mexico  
(905) 596-79-33

#### For all other areas:

Hewlett-Packard Company  
Intercontinental Headquarters  
3495 Deer Creek Road  
Palo Alto, CA 94304 U.S.A.



Data Subject to Change

4/3/91/R  
Printed in U.S.A.  
October, 1988  
5952-4191